

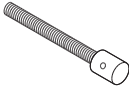

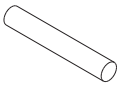

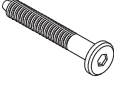



SPINDLE BED - KING SIZE ASSEMBLY INSTRUCTION FOR BED INSTALLATION

HARDWARE ENCLOSED

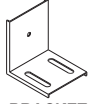
 HALF MOON WASHER 4pcs	 BOLT M8x100 mm 4pcs	 DOWEL Ø12x50 mm 8pcs	 JCBC BOLT M6x70 mm 4pcs	 LONG NUT M6 2pcs
 SPRING WASHER M6 2pcs	 WASHER M6 6pcs	 L BRACKET 8pcs	 JCBC SCREW M6x6mm 8pcs	 JF SCREW M6x50mm 5pcs
				 NUT M6 4pcs

TOOLS

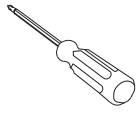
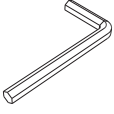
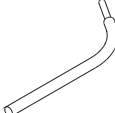
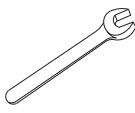
 SCREWDRIVER (Not included in package)	 L KEY (Included in package)
 BOLT KEY (Included in package)	 WRENCH (Included in package)

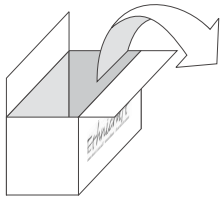

IN YOUR PACKAGE :

ASSEMBLY INSTRUCTION

HARDWARE (AS LISTED ABOVE)

PARTS TO BE INSTALLED

- 1) HEADBOARD 1 piece
- 2) SIDERAIL 2 pieces
- 3) FOOTBOARD 1 piece
- 4) CENTER SUPPORT 1 piece
- 5) CENTER LEG 1 piece
- 6) HEADBOARD PANEL 1 piece

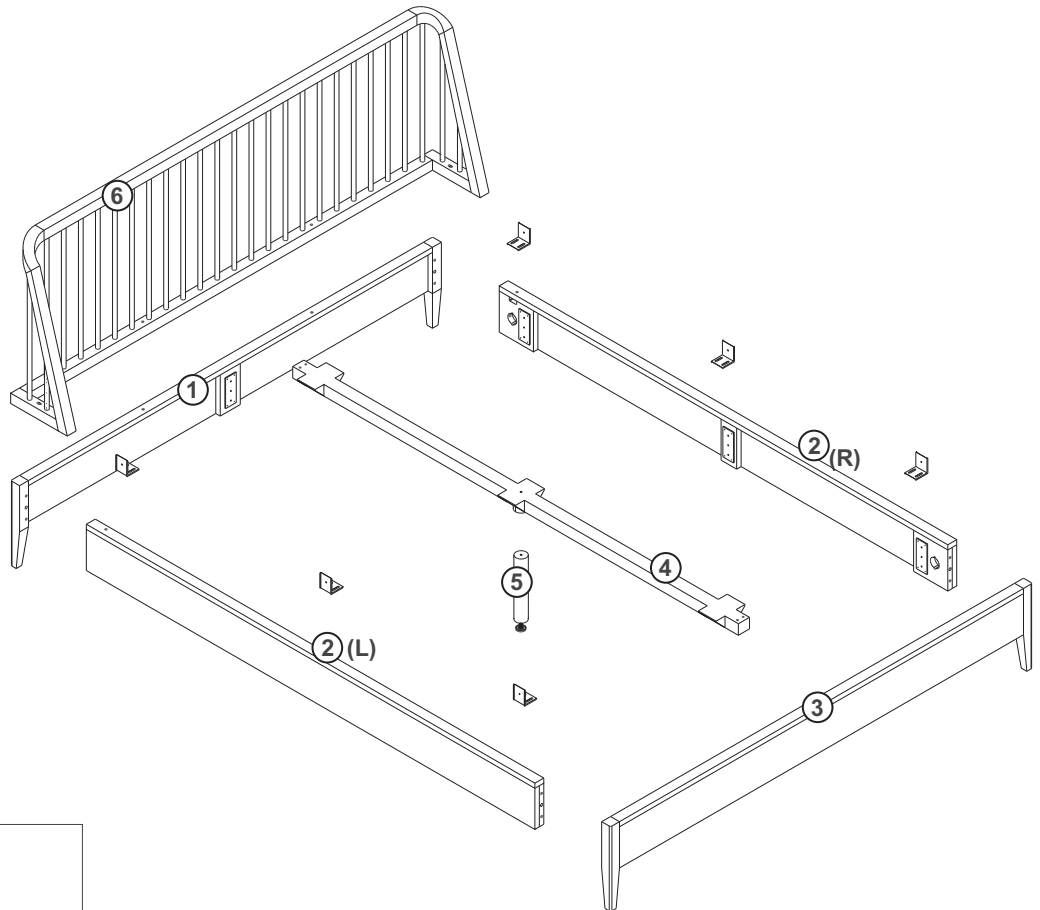

NOTICE

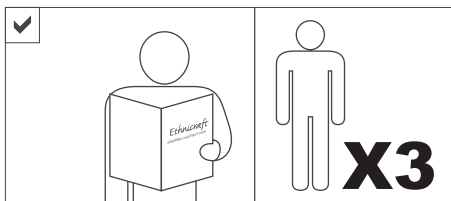

SYMBOLS



DIRECTION

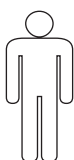

NUMBER OF PERSONS NEEDED



USE SCREWDRIVER TO TIGHTEN



USE WRENCH TO TIGHTEN



USE L KEY TO TIGHTEN



USE HAND

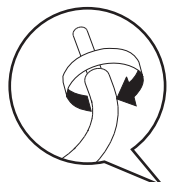

USE BOLT KEY TO TIGHTEN

SPINDLE BED - KING SIZE ASSEMBLY INSTRUCTION FOR BED INSTALLATION

A. CONNECTING SIDERAIL-HEADBOARD-FOOTBOARD

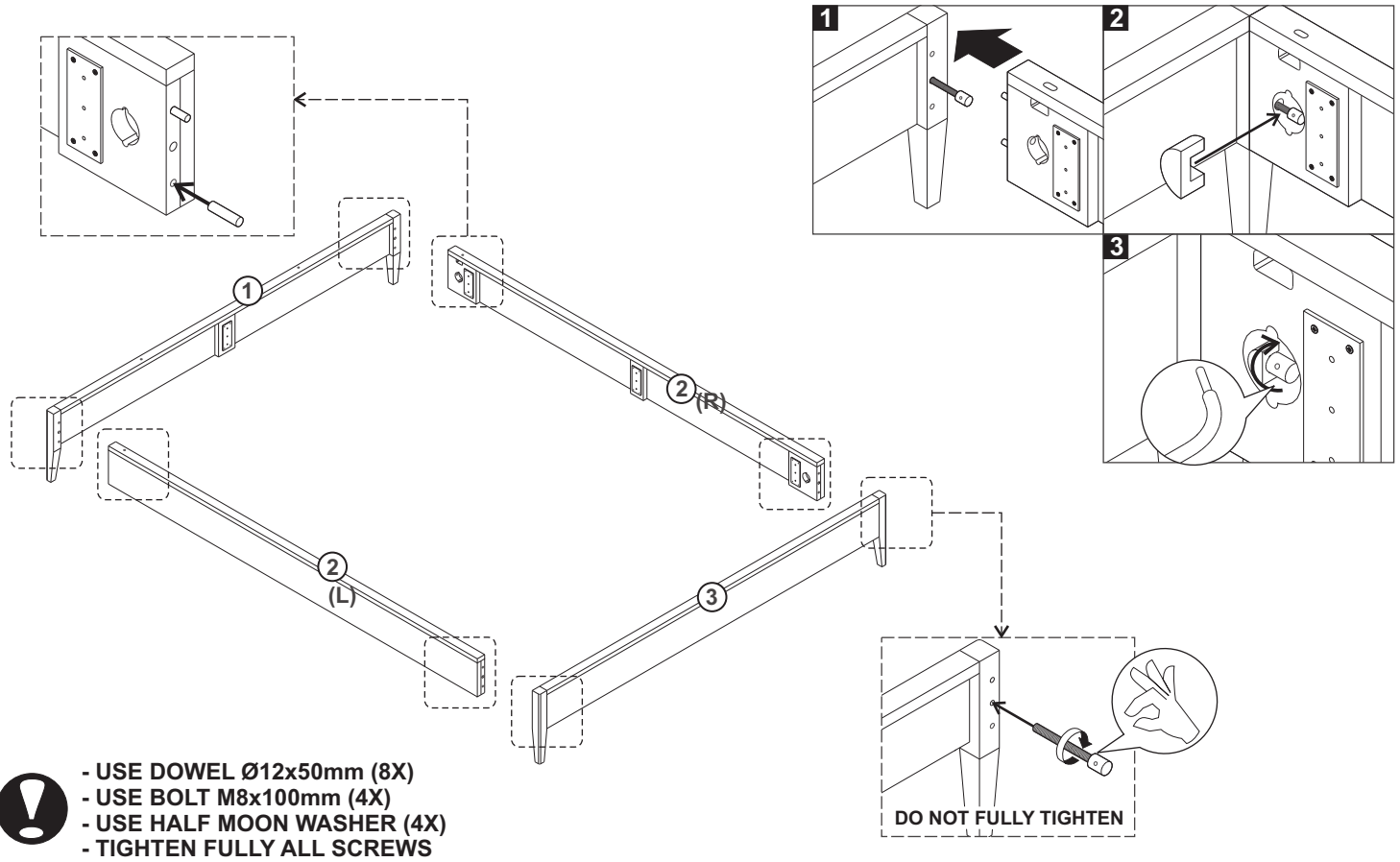

B. CONNECTING CENTER LEG TO CENTER SUPPORT

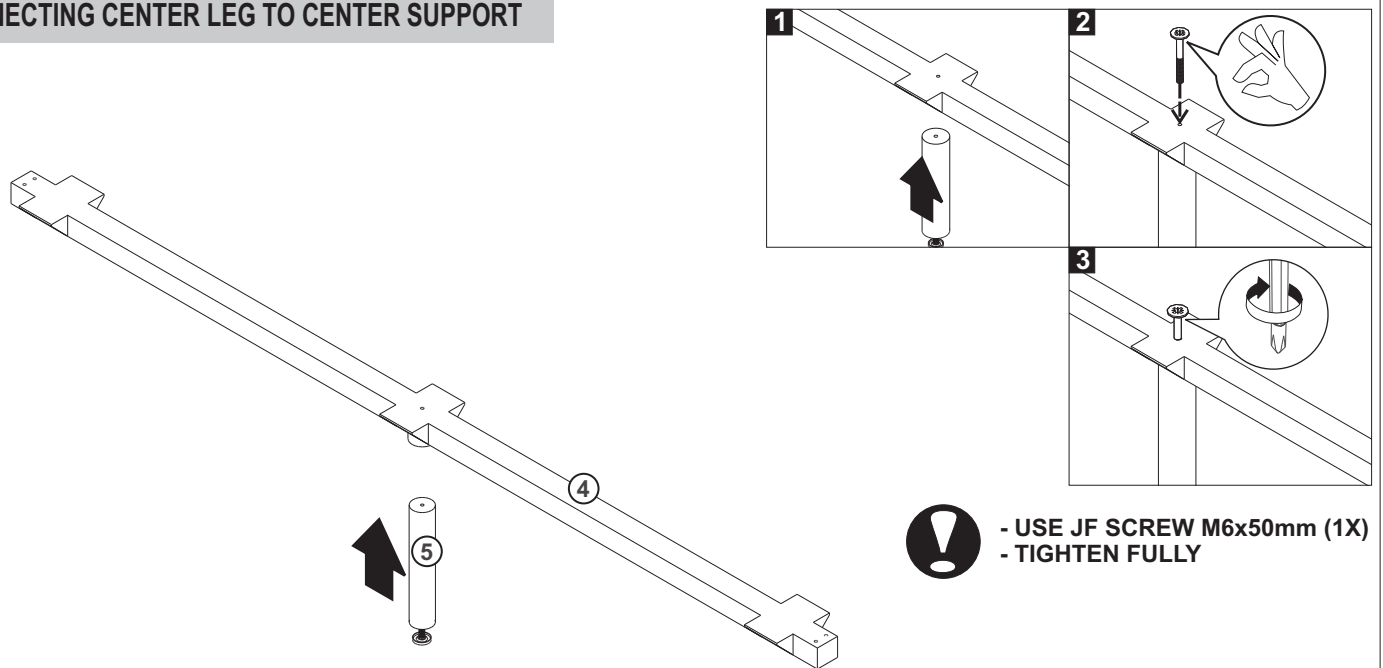

SPINDLE BED - KING SIZE ASSEMBLY INSTRUCTION FOR BED INSTALLATION

C. INSTALLING CENTER SUPPORT

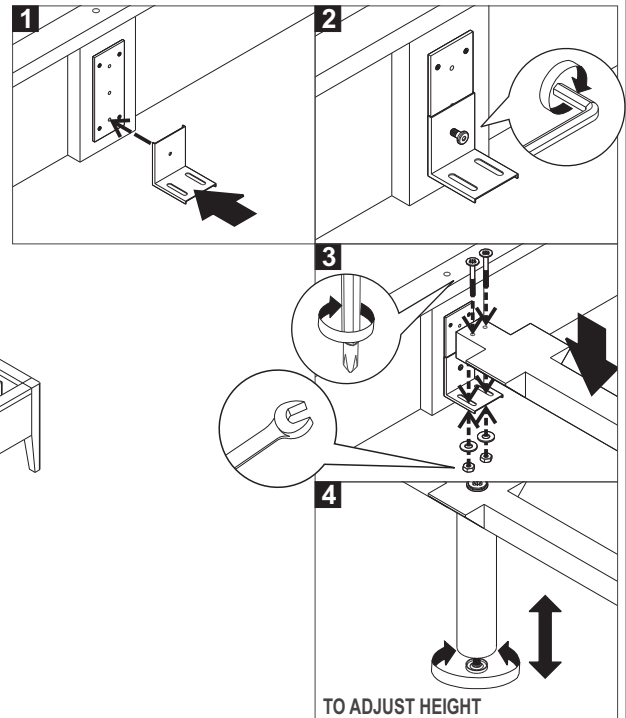
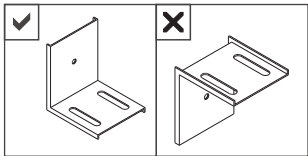
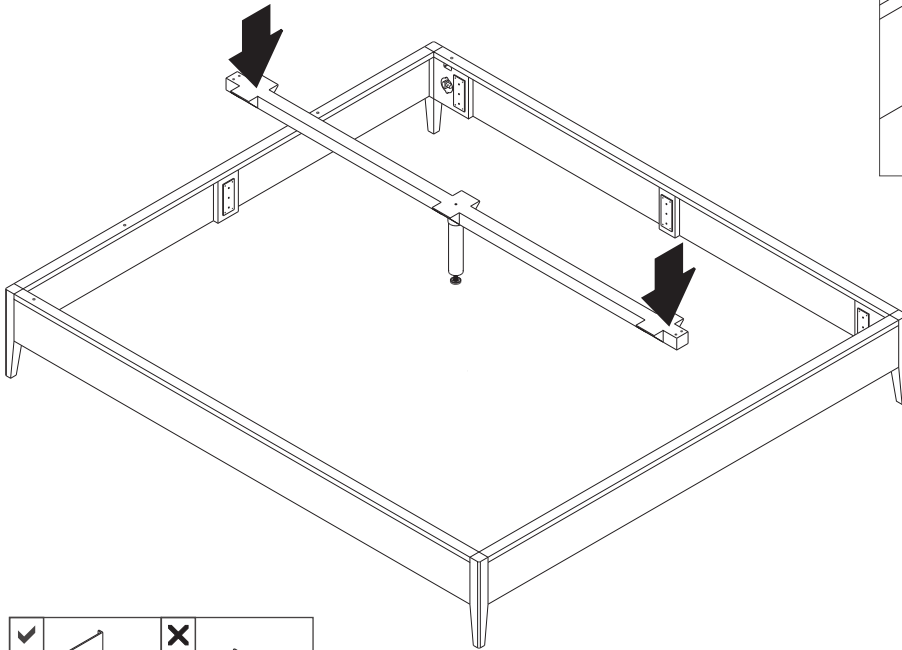

- USE JCBC SCREW M6x6mm (2X)
- USE JF SCREW M6x50mm (4X)
- USE WASHER M6 (4X)
- USE NUT M6 (4X)
- TIGHTEN FULLY ALL SCREWS



D. INSTALLING L BRACKET

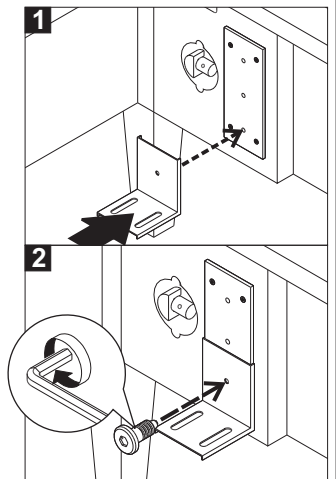
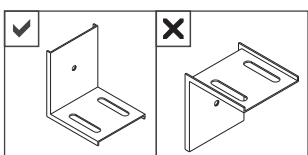
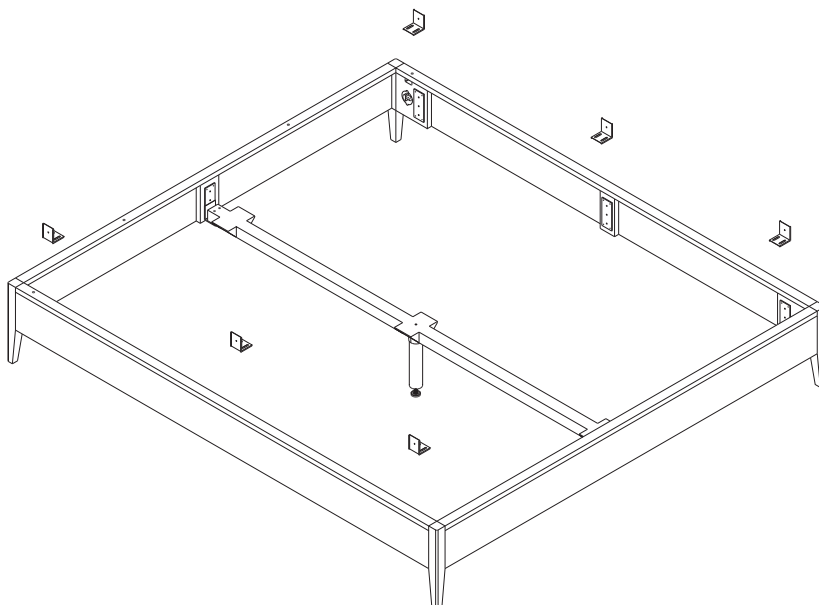

- USE JCBC SCREW M6x6mm (6X)
- TIGHTEN FULLY ALL SCREWS
- INSTALLING L BRACKET AT THE SAME LEVEL WITH CENTER SUPPORT



SPINDLE BED - KING SIZE ASSEMBLY INSTRUCTION FOR BED INSTALLATION

E. INSTALLING HEADBOARD PANEL

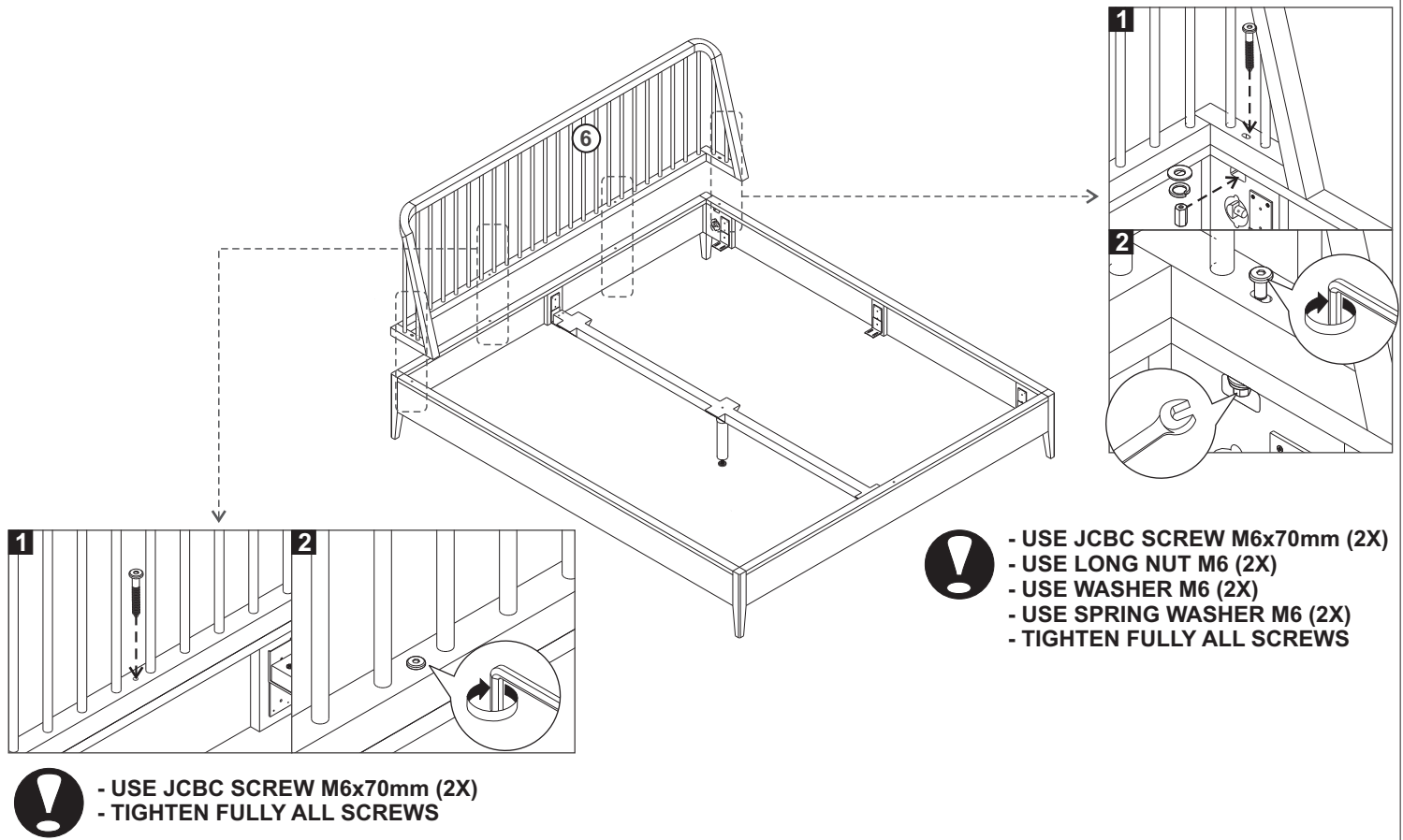

F. FINISH

